

## DIAPHRAGM PUMPS

# BOXER 150

MADE IN ITALY



- **Product of Italian origin**
- **Patented** stall protection pneumatic circuit
- Works with **non**-lubricated air
- **Self priming**
- Idles without damage
- Possibility of adjusting the pumping speed
- Versatility of use
- Broad choice of materials that are compatible with the fluid to be pumped
- Particularly suitable for heavy duty applications
- Atex zone 1 (*on request*) - Atex zone 2 standard
- Customisable suction/delivery fitting position (*on request*)
- Available with NPT fittings (*on request*)
- Available with clamp / din connections (*on request, only for stainless steel pumps*)
- Diaphragms with "long life" profile
- Diaphragms in various materials
- Suitable for pumping high viscosity fluids
- High performance
- High power and sturdiness
- Continuous operation: YES
- Warranty: 1 year - according to our general conditions of sale
- Spare parts: to identify the spare parts check the exploded views provided at the end of the operation and maintenance manual

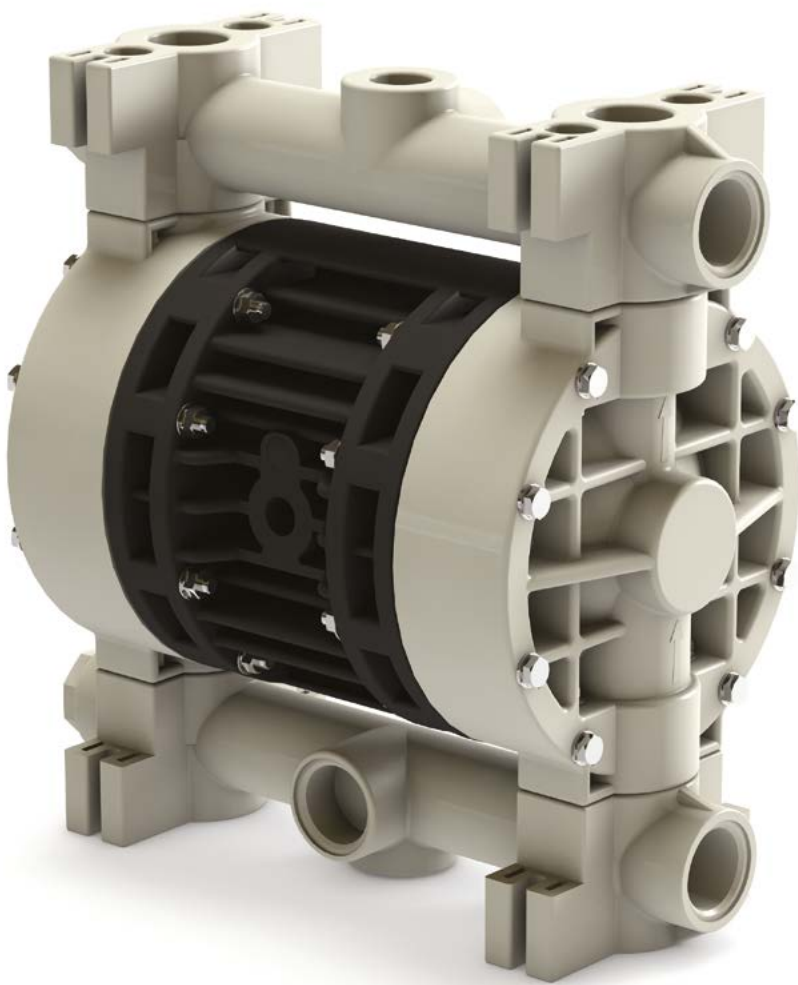

 **STANDARD:** II 3/3 GD c IIB T135°C (zone 2)  
**CONDUCT:** II 2/2 GD c IIB T135°C (zone 1)

**Intake/delivery connections** G 1" 1/4 f o DN 32 (\*) - flow rate 220 l/min

**Construction materials** PP - PVDF - Alu - AISI 316

(\*) NPT connections on request



# DIAPHRAGM PUMPS

## BOXER 150



**STANDARD:** II 3/3 GD c IIB T135°C (zone 2)  
**CONDUCT:** II 2/2 GD c IIB T135°C (zone 1)

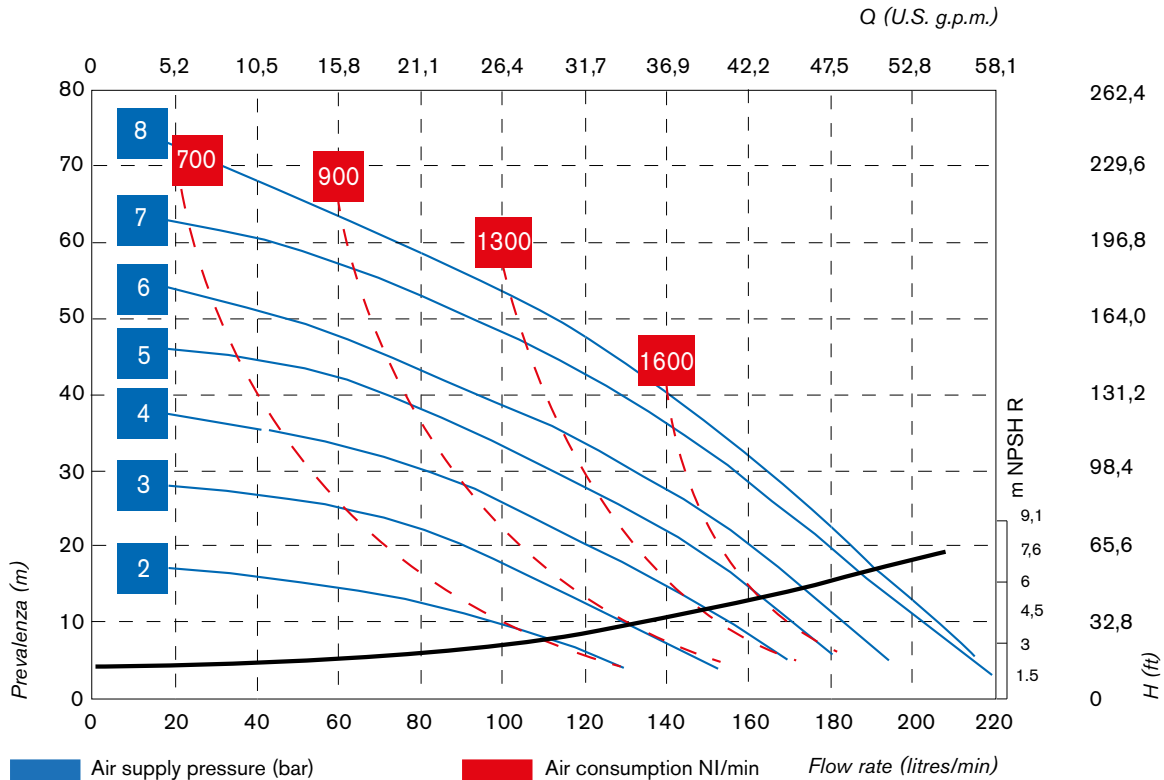

\* The curves and performance values refer to pumps with submerged suction and a free delivery outlet with water at 20°C, and vary according to the construction material. \*\* Attention: the average values of the various configurations of materials by ball and ball seats. \*\*\* The value depends on the configuration of the pump.

Guaranteed head/flow rate according to ISO 9906

<b>Intake/delivery connections</b>	G 1" 1/4 f o DN 32 (*)
<b>Air connection</b>	G 1/2" f
<b>Max. flow rate*</b>	220 l/min
<b>Max. air supply pressure</b>	8 bar
<b>Max. head*</b>	80 m
<b>Max. self-priming capacity**</b>	4 m
<b>Max. stored neg. suction</b>	9,5
<b>Max. diameter of passing solids</b>	5 mm
<b>Noise***</b>	75 dB
<b>Displacement per cycle</b>	340 cc
<b>Max. viscosity</b>	40.000 cps

(\*) NPT connections on request

Construction materials and net weight	PP	12 Kg	Temp. 3°C min. 65°C max.
	PP+CF	12 Kg	Temp. 3°C min. 65°C max.
	PVDF	14 Kg	Temp. 3°C min. 95°C max.
	Alu	16 Kg	Temp. 3°C min. 95°C max.
	AISI 316	21 Kg	Temp. 3°C min. 95°C max.

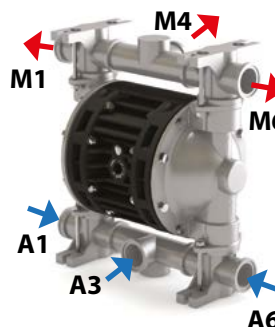
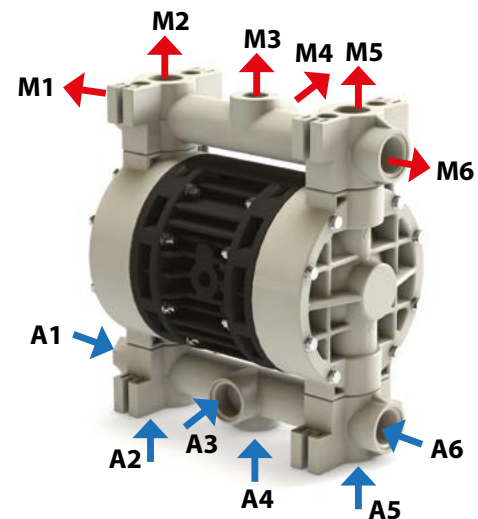

BOXER150 (PLASTIC): A1-A2-A3-A4-A5-A6-M1-M2-M3-M4-M5-M6  
 BOXER150 (Alu): A1-A2-A3-A4-A5-A6-M1-M2-M3-M4-M5-M6

BOXER150 (AISI 316): A1-A3-A6 - M1-M4-M6

# DIAPHRAGM PUMPS

# BOXER 150



**Ex** STANDARD: II 3/3 GD c IIB T135°C (zone 2)  
 CONDUCT: II 2/2 GD c IIB T135°C (zone 1)

## AVAILABLE MATERIALS

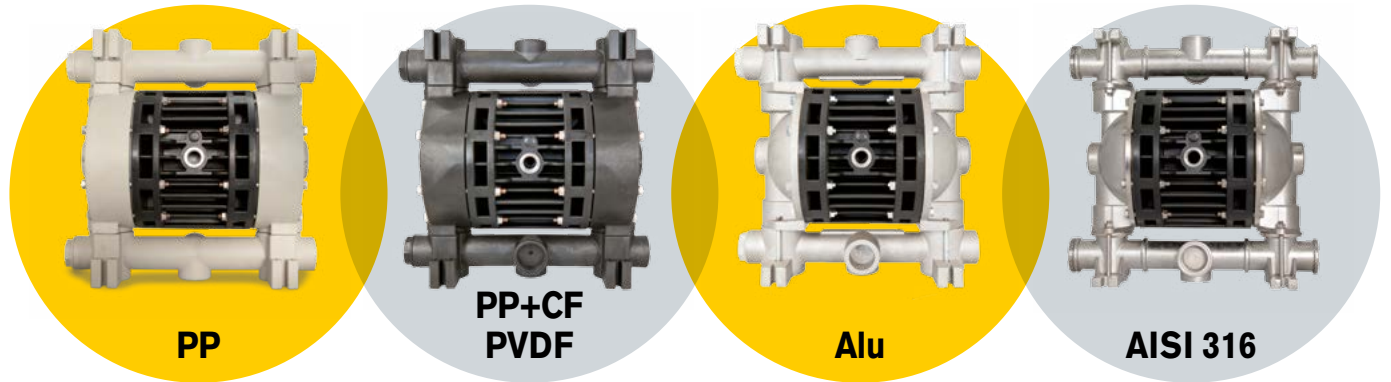

## INSTALLATION

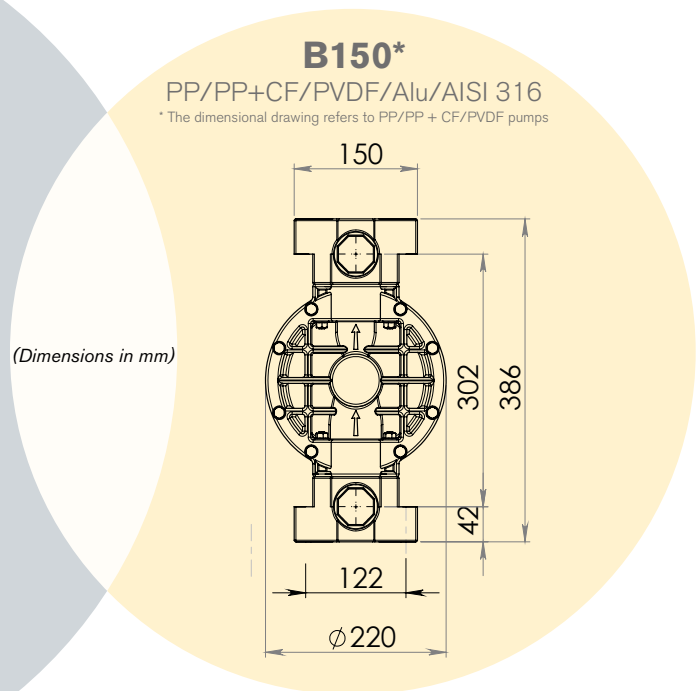
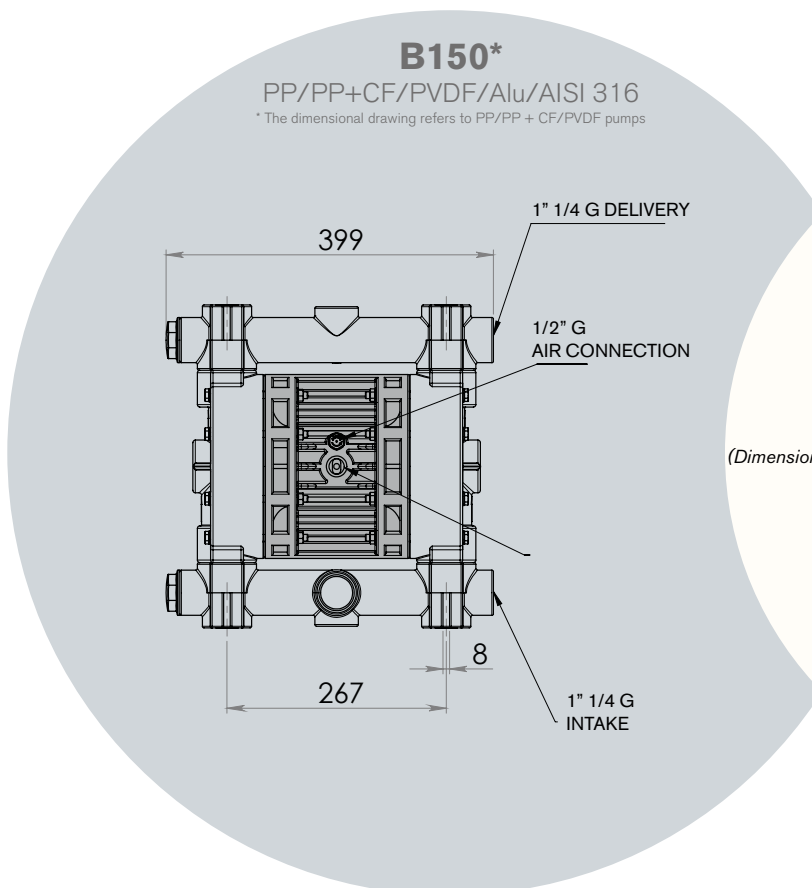
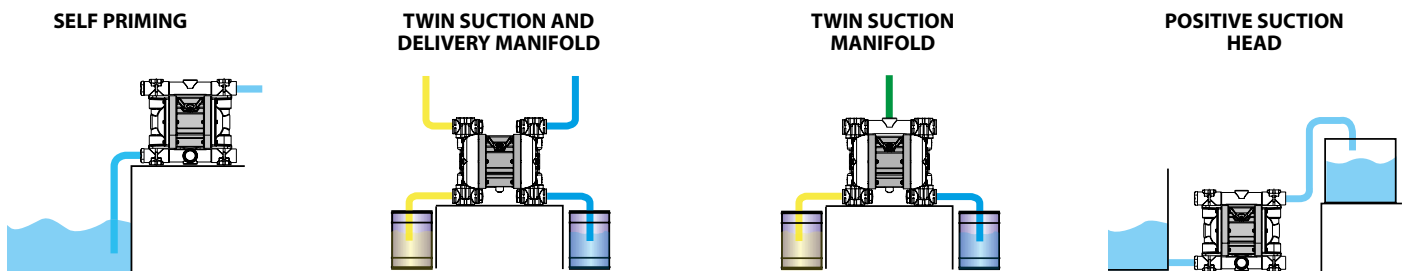

**Packaging:** cardboard box - 29 x 47 x 46 cm - weight: 1.4 Kg  
 (the weight only refers to the packaging without the pump in it).

# DIAPHRAGM PUMPS

# BOXER 150



**Ex** STANDARD: II 3/3 GD c IIB T135°C (zone 2)  
 CONDUCT: II 2/2 GD c IIB T135°C (zone 1)

## BOXER COMPOSITION CODE

ex. **IB150 - P - H - T - T - P - V**

Internal Exchanger, Boxer 150, body PP, air side diaphragm Hytrel, fluid side diaphragm PTFE, balls PTFE, ball seats PP, O-Ring in Viton.

I	B150 -	P -	H	T	T	P	V	-	-
INTERNAL EXCHANGER	PUMP MODEL	PUMP BODY	AIR SIDE DIAPHRAGM	FLUID SIDE DIAPHRAGM	BALLS	BALL SEATS	O-RING	TWIN MANIFOLD	CONDUCT VERSION
I	B150 - Boxer 150	P - PP PC - PP + CF FC - PVDF + CF AL - Alu A - AISI 316	H - Hytrel M - Santoprene D - EPDM N - NBR	T - PTFE*	T - PTFE A - AISI 316 D - EPDM N - NBR	P - Polypropylene F - PVDF A - AISI 316 R - PPS-V I - HMWHDPE	T - PTFE D - EPDM V - Viton N - NBR	X	C

\*) Cover diaphragms (only on Hytrel and Santoprene diaphragms) cannot be fitted individually.

## PRODUCT APPLICATION

